

# HARMONIE

# PBAA

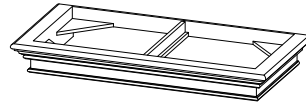

x1

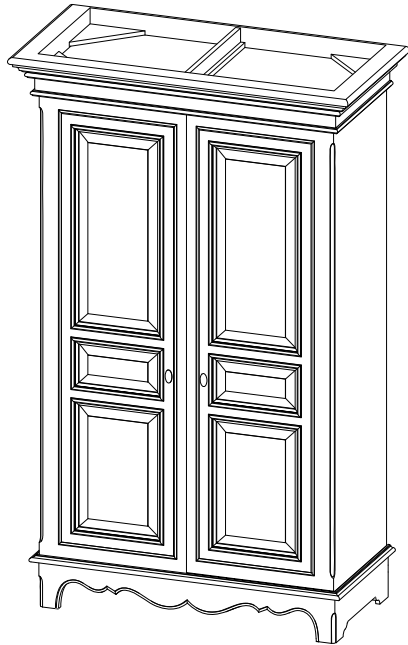
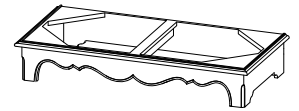

x1

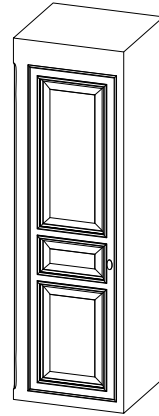

x1

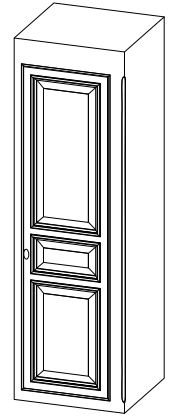

x1



x1



x1



x2



x2

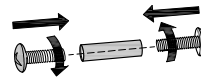

x3



x24



x2



M4x35

x4

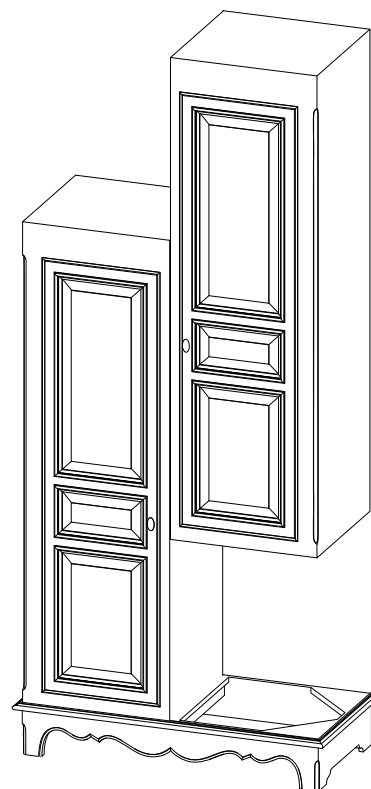
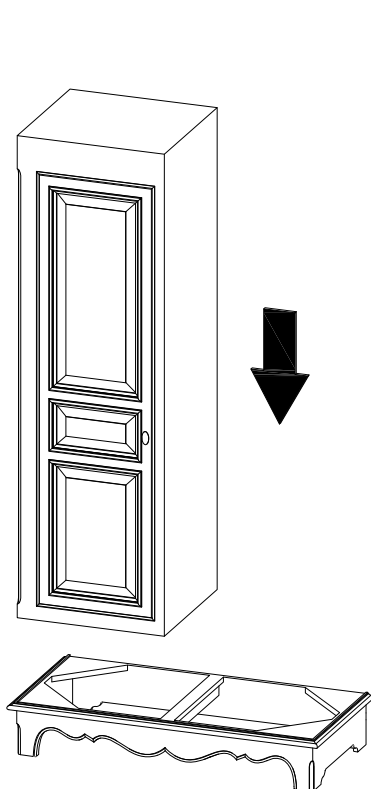

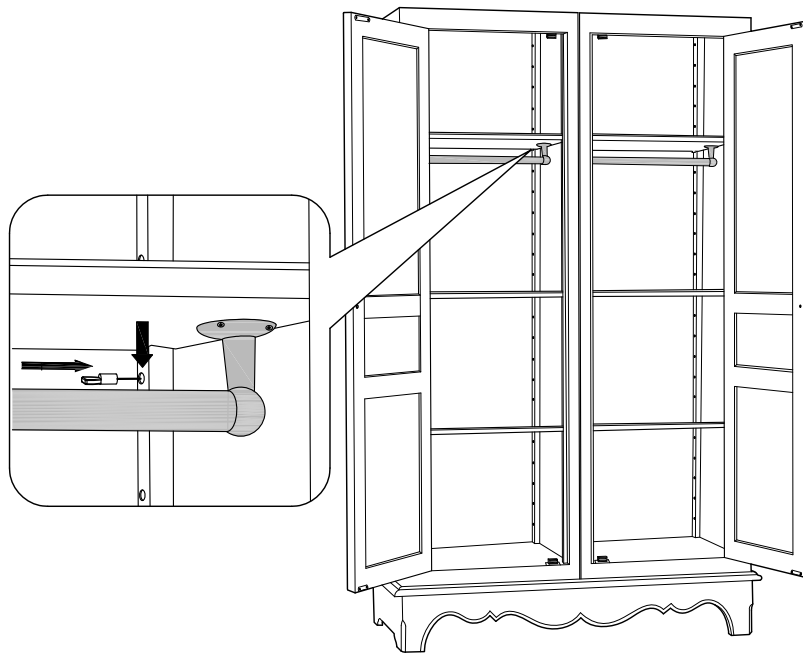
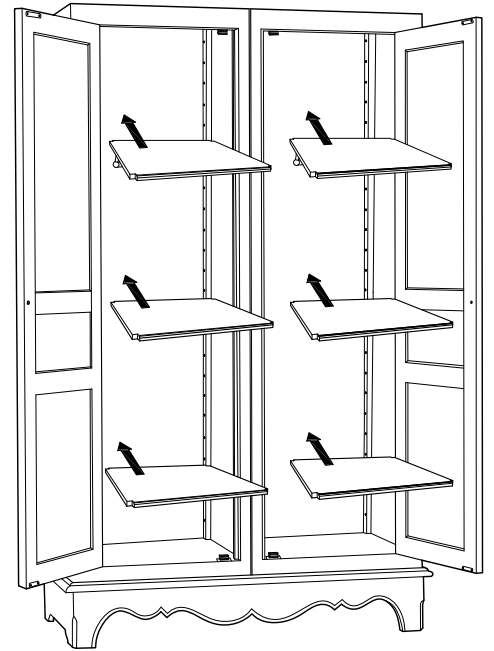
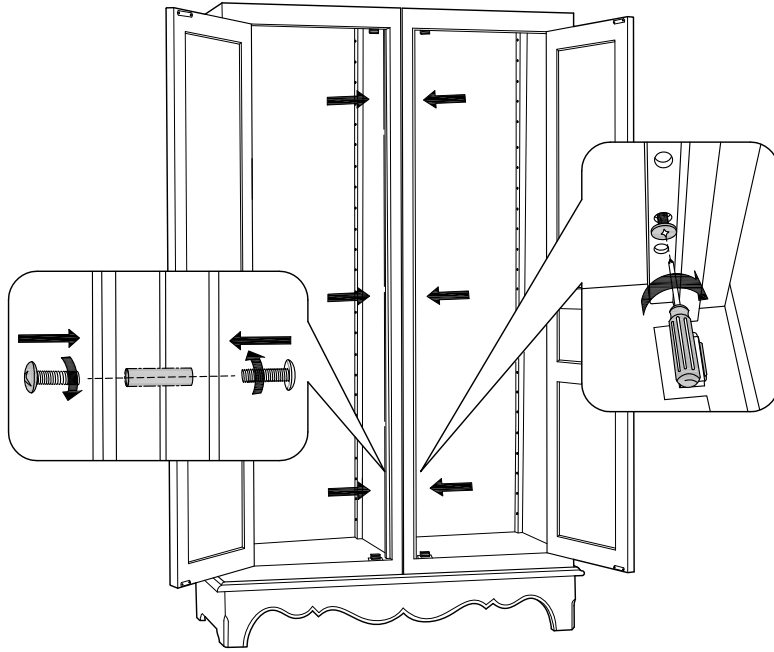

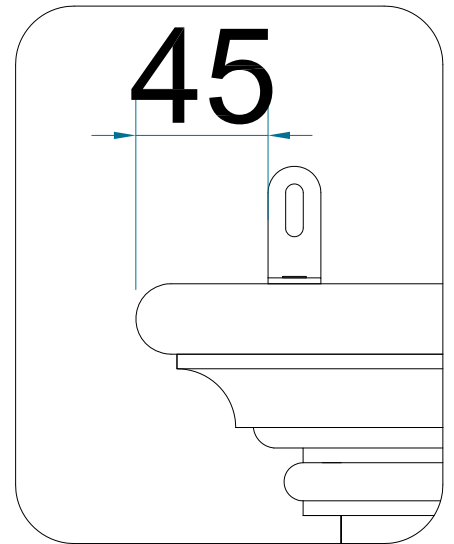
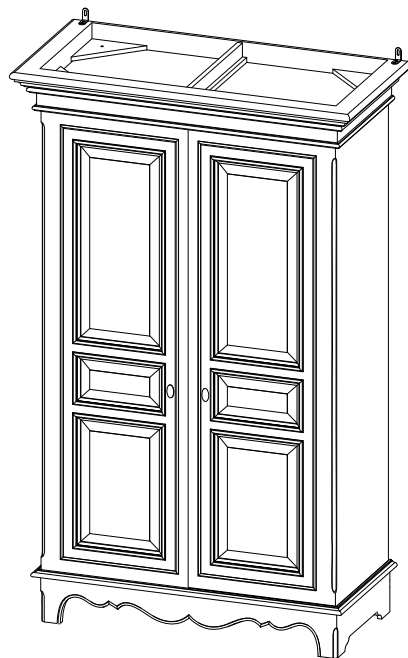
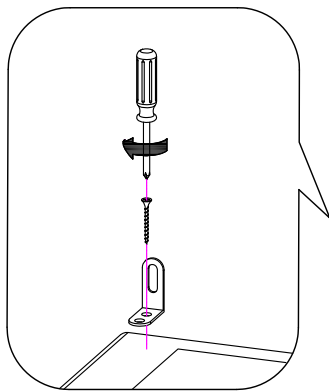
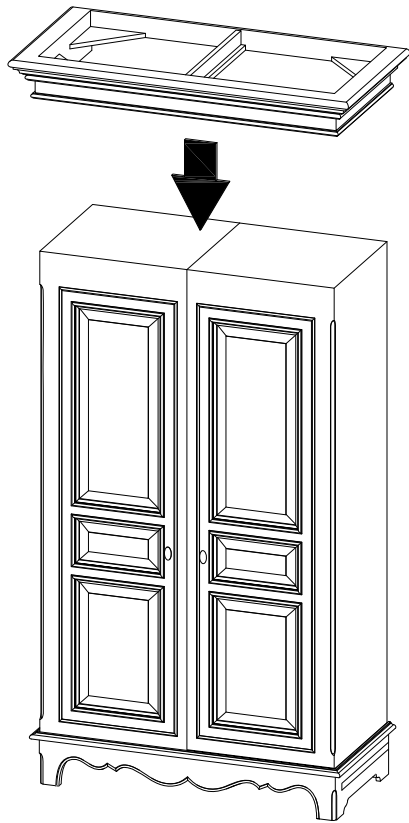

# GUIDE DE FIXATION MURALE

Si le matériau de votre cloison n'est pas répertorié ou si vous avez des questions, renseignez-vous auprès d'un magasin de bricolage.

Pour éviter tout risque de basculement, ce meuble doit être accroché au mur à l'aide de l'accessoire de fixation murale inclus. Utiliser le type de vis et chevilles adaptées au support.

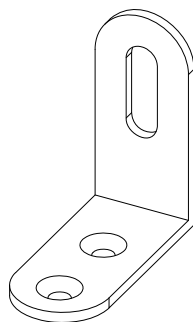

## MATÉRIAU DE LA CLOISON

Cloison en plâtre avec ossature bois accessible.

## DISPOSITIF DE FIXATION

Vis insérée directement dans l'ossature.

Par exemple,

une vis à bois de 5 mm de notre set de chevilles et vis FIXA.

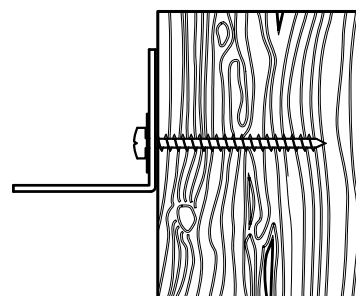

FIGURE 1

---

## MATÉRIAU DE LA CLOISON

Cloison en plâtre sans ossature bois accessible

## DISPOSITIF DE FIXATION

Vis avec cheville.

Par exemple,

une cheville de 8 mm de notre set de vis et chevilles FIXA.

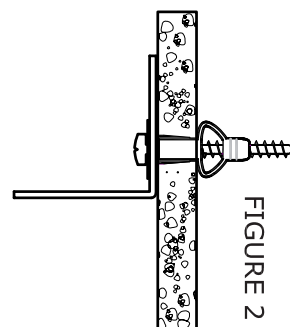

FIGURE 2

---

## MATÉRIAU DE LA CLOISON

Maçonnerie

## DISPOSITIF DE FIXATION

Mur plein : vis avec cheville.

Par exemple,

une cheville de 8 mm de notre set de vis et chevilles FIXA.

(figure 3A)

Mur creux : cheville à expansion.

(figure 3B)

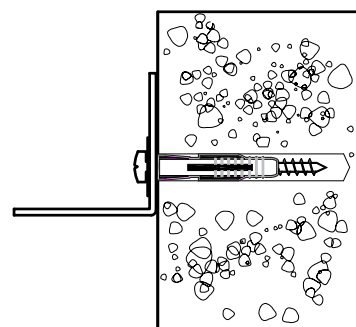

FIGURE 3A

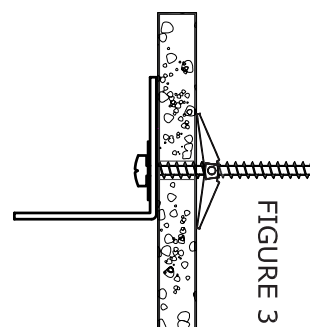

FIGURE 3B